

FIRE RATED FRAME PROFILES

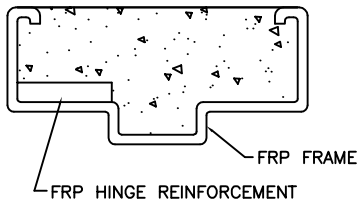

FIRE RATED FRAME SECTION

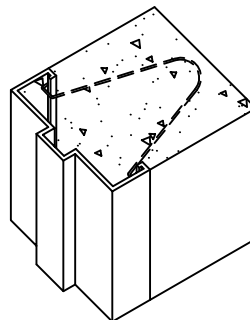

OPTION GWA-CIP

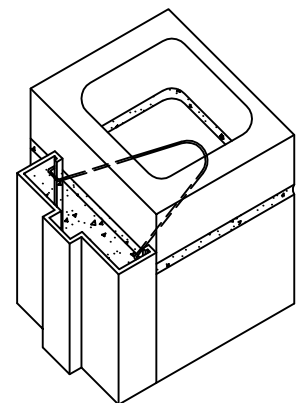

OPTION GWA-CMU

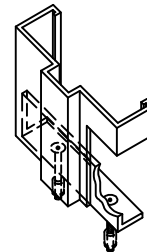

FLOOR ANCHOR
FIRE RATED FRAME ANCHOR

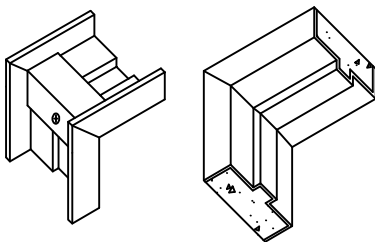

STANDARD KD
KNOCK DOWN
NEW WALL CONSTRUCTION ONLY

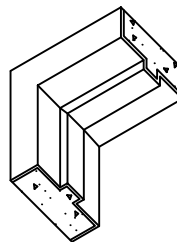

OPTION WF
CHEMICALLY WELDED FACE
NEW WALL CONSTRUCTION ONLY



FIRE RATED GROUTED FRAME HEAD/JAMB ATTACHMENT OPTIONS

FIRE RATED FIBERGLASS DOOR FRAME DETAILS FOR GROUTED INSTALLATION		
DATE 4/02/12	SCALE NONE	
DWG NAME RATEDFRAMEGWA	DRAWN BY BG	